

Mi Robot Vacuum-Mop 2 Pro+

User Manual



Welcome

Thank you for choosing the Mi Robot Vacuum-Mop 2 Pro+!

The Mi Robot Vacuum-Mop 2 Pro+ is an intelligent all-in-one cleaner designed for ultimate convenience and cleaning efficiency. Equipped with high-precision motion sensors, obstacle avoidance technology, and an innovative visual navigation system, the Mi Robot Vacuum-Mop 2 Pro+ quickly maps out its surroundings and generates cleaning routes as it goes. Thanks to its intuitive obstacle detection and high wheel clearance design, the Mi Robot Vacuum-Mop 2 Pro+ can easily navigate complex home layouts. Once a cleaning task is completed, the Mi Robot Vacuum-Mop 2 Pro+ automatically returns to the charging dock, delivering a hassle-free experience from start to finish. Using its high-powered suction and electronically-controlled water mopping system, the Mi Robot Vacuum-Mop 2 Pro+ cleans by sweeping in front and mopping in back for amazing results every time. The Mi Home/Xiaomi Home app also makes it easy to view your cleaning map, schedule a cleaning, and switch between cleaning modes, allowing you to clean your entire home at the touch of a button. Thank you for choosing the Mi Robot Vacuum-Mop 2 Pro+, and welcome to the future of smart living!

Read this manual carefully before use, and retain it for future reference.

Hereby, Dreame (Tianjin) Information Technology Co., Ltd. declares that the radio equipment type STYTJ02ZHM is in compliance with Directive 2014/53/EU. The full text of the EU declaration of conformity is available at the following internet address:
<http://www.mi.com/global/service/support/declaration.html>

Safety Information

Only for navigation and positioning purposes, the camera of the vacuum-mop will collect individuals in the surroundings within the range of the viewing angles when it is cleaning. Please be assured that all your personal information will be protected by the data encryption technology.

Usage Restrictions

This product is for floor cleaning in a home environment only. Do not use it outdoors, on non-floor surfaces, or in a commercial or industrial setting.

This appliance can be used by children aged from 8 years and above and persons with reduced physical, sensory or mental capabilities or lack of experience and knowledge if they have been given supervision or instruction concerning use of the appliance in a safe way and understand the hazards involved. Children shall not play with the appliance. Cleaning and user maintenance shall not be made by children without supervision.

Ensure children and pets are kept at a safe distance from the vacuum-mop while it is operating. If the power cord is damaged, it must be replaced by a special cord or assembly available from the manufacturer or its service agent.

Do not use the vacuum-mop in an area suspended above ground level without a protective barrier. Do not use the vacuum-mop at an ambient temperature above 40°C or below 0°C or on a floor with liquids or sticky substances.

Pick up any cables from the floor before using the vacuum-mop to prevent it from dragging them while cleaning.

Remove fragile or small items from the floor to prevent the vacuum-mop from bumping into and damaging them.

Safety Information

Keep the brush cleaning tool out of reach of children.

Do not place children, pets, or any item on top of the vacuum-mop regardless of whether it is stationary or moving.

Keep hair, fingers, and other body parts away from the suction opening of the vacuum-mops.

Do not use the vacuum-mop to clean any burning substances.

Do not vacuum up hard or sharp objects.

Make sure the vacuum-mop is turned off and the charging dock is unplugged before cleaning or performing maintenance.

Do not wipe any part of this product using a wet cloth or any liquids.

Make sure the vacuum-mop is turned off when being transported and kept in its original packaging if possible.

Please use this product in accordance with the instructions in the User Manual. Users are responsible for any loss or damage arising from improper use of this product.

Batteries and Charging

WARNING: Do not use any third-party battery. Use only with CDZ1902 charging dock.

Do not attempt to disassemble, repair, or modify the battery or charging dock on your own.

Do not place the charging dock near a heat source.

Do not use a wet cloth or wet hands to wipe or clean the dock's charging contacts.

Safety Information

If the vacuum-mop won't be used for an extended period, fully charge it, then turn it off and store in a cool, dry place. Recharge the

vacuum-mop at least once every 3 months to avoid over-discharging the battery.

This appliance contains batteries that are only replaceable by skilled persons.

The lithium-ion battery pack contains substances that are hazardous to the environment. Before disposing of the Vacuum-Mop, please first remove the battery pack, then discard, or recycle it in accordance with local laws and regulations of the country or region it is used in.

When removing the batteries from the product, it is better to use up the batteries and make sure your product is disconnected from power. Uninstall the screw on the bottom, then remove the cover.

Unplug the battery connector, then remove the batteries. Do not damage the battery case to avoid any risk of injuries.

Return the batteries to a professional recycling organization.

Product Overview

Accessories

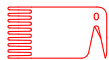

Cleaning Tool

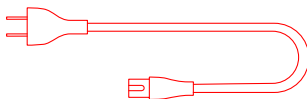

Power Cord



Side Brush

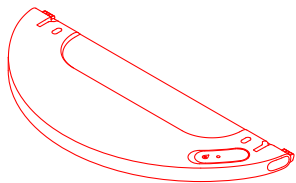

Water Tank

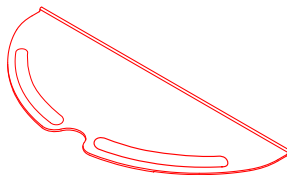

Mop Pad

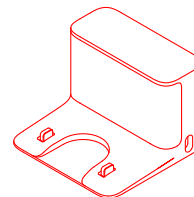

Charging Dock

Note: Illustrations of product, accessories, and user interface in the user manual are for reference purposes only. Actual product and functions may vary due to product enhancements.

Product Overview

Vacuum-Mop

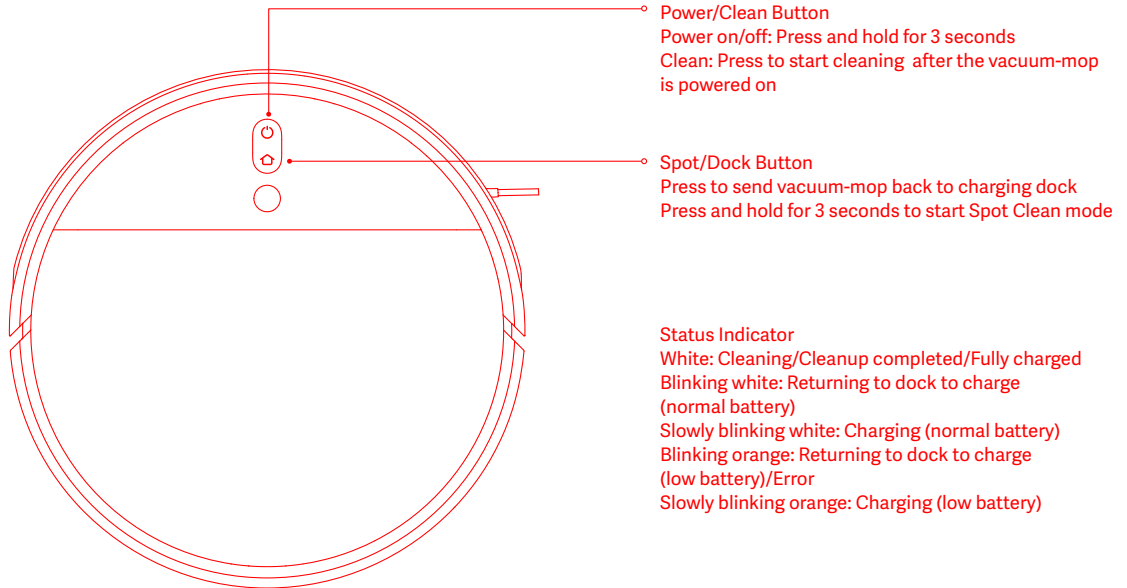

Note: Press any button to pause while the vacuum-mop is cleaning, returning to dock, or in Spot Clean mode.

Product Overview

Dust Compartment

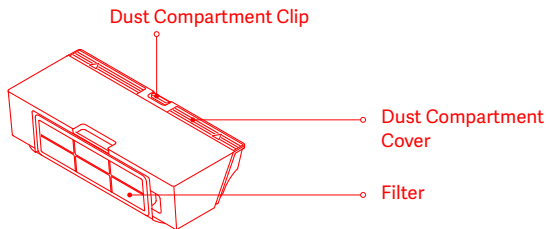

Mopping Assembly

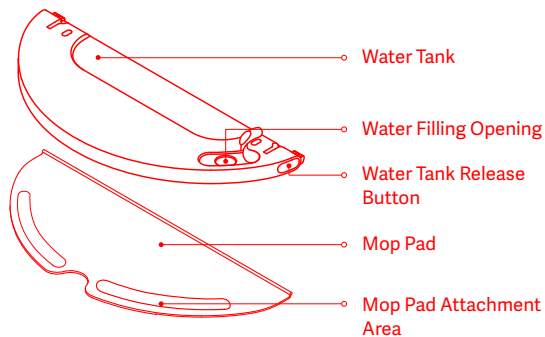

Vacuum-Mop

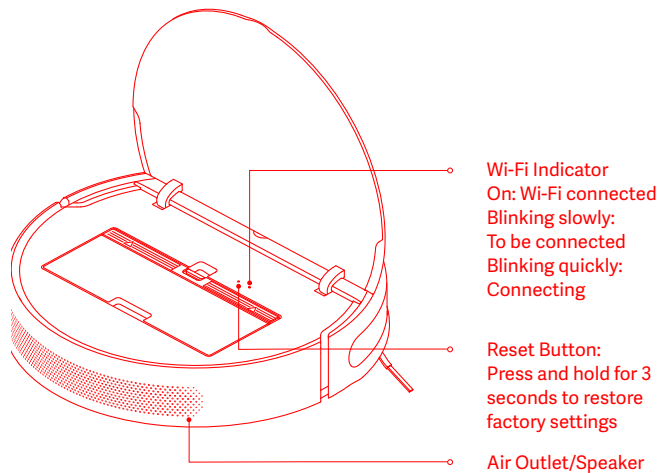

Product Overview

Vacuum-mop and Sensors

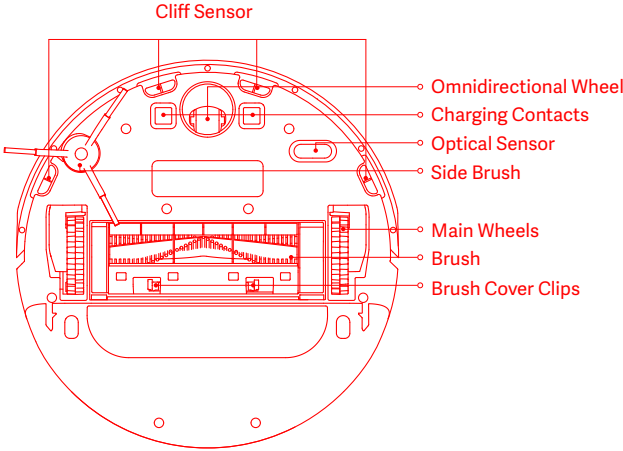

Vacuum-mop and Sensors

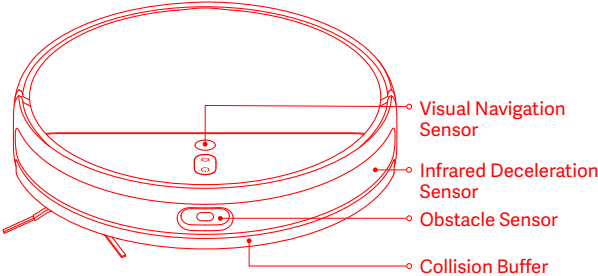

Charging Dock

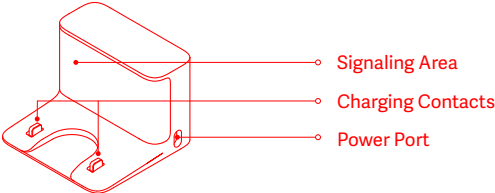

Before Use

Remove Protective Coverings

Remove the protective strips from both sides of the vacuum-mop's bumper as well as the protective film on the visual navigation sensor and charging dock.

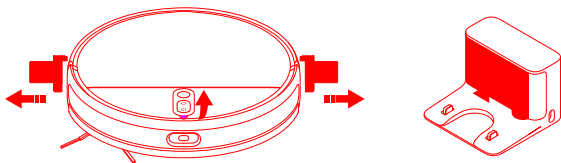

Install the Side Brush

Insert the side brush into the attachment slot on the bottom of the vacuum-mop.

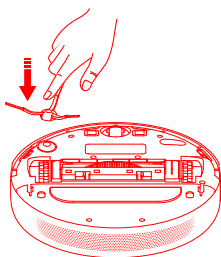

Position and Connect the Charging Dock

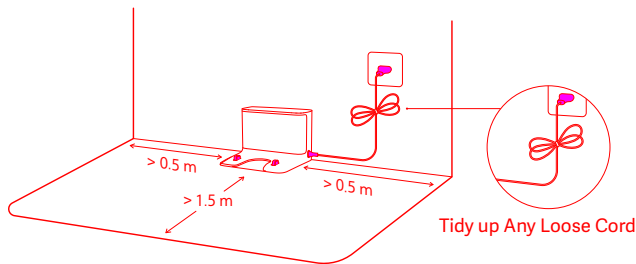

Place the charging dock near an electrical outlet in an area with a good Wi-Fi signal. To ensure the vacuum-mop can return to the charging dock, leave at least 0.5 meters of clearance on either side of the charging dock and at least 1.5 meters of open space in front, and make sure no objects are directly overhead. Do not place the charging dock under furniture, such as a cabinet, or chair. Connect the power cord to the charging dock and tidy up any loose cord to prevent the vacuum-mop from getting tangled, which could accidentally move or unplug the charging dock.



Note: Make sure the charging dock is in a well-lit area out of direct sunlight and away from reflective objects, such as mirrors, which can prevent the vacuum-mop from returning to the charging dock.

Before Use

Charge the Vacuum-mop

Place the vacuum-mop onto the charging dock. The vacuum-mop will automatically turn on and begin charging. The indicators of buttons  and  on the vacuum-mop will slowly blink white while charging, and remain lit once fully charged.

Battery Level Indicator

White:

Battery level > 15%

Orange:

Battery level ≤ 15%

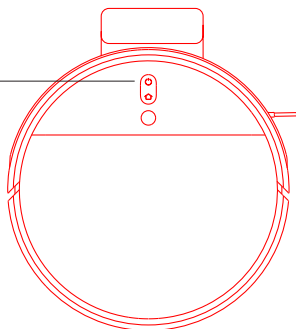

Notes:

- Fully charge the vacuum-mop before using it for the first time. This will take about 6 hours.
- To ensure safety while charging and to prevent the mop pad from damaging floor surfaces, please remove the mopping assembly prior to charging.

Connect with Mi Home/Xiaomi Home App

This product works with the Mi Home/Xiaomi Home app*. Use the Mi Home/Xiaomi Home app to control your device, and to interact with other smart home devices.

Scan the QR code to download and install the app. You will be directed to the connection setup page if the app is installed already. Or search "Mi Home/Xiaomi Home" in the app store to download and install it. Open Mi Home/Xiaomi Home app, tap "+" on the upper right, and then follow prompts to add your device.





* The app is referred to as Xiaomi Home app in Europe (except for Russia). The name of the app displayed on your device should be taken as the default.

Notes:



- Only 2.4 GHz Wi-Fi networks are supported.
- The version of the app might have been updated, please follow the instructions based on the current app version.

Reset Wi-Fi

When there is a connection loss between your phone and the vacuum-mop due to the router reconfiguration, wrong password or so, please open the cover of the vacuum-mop so that you can see the Wi-Fi indicator. Simultaneously press and hold the buttons  and  until you hear a voice saying "Waiting for the network configuration". Once the Wi-Fi indicator is slowly blinking, the Wi-Fi has been successfully reset.

How to Use

Start Cleaning

Press and hold the button  for 3 seconds to turn on the vacuum-mop. The power indicator will turn white to indicate that the vacuum-mop is in standby mode. Press the button , and the vacuum-mop will start cleaning in an S-shape pattern. Once all areas are cleaned, the vacuum-mop will finish by cleaning along edges and walls, then return to the charging dock to recharge.

If the vacuum-mop starts running low on battery during a cleaning task, it will automatically return to the charging dock to recharge, then resume cleanup where it left off after being charged sufficiently.

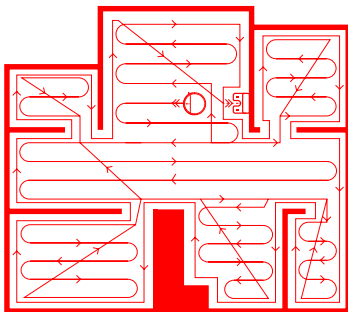



During a cleaning task, the vacuum-mop may enter and exit rooms and detect boundaries by gently bumping into walls and furniture. This is normal and does not affect cleaning efficiency.

Notes:

- Before a cleaning task, make sure the vacuum-mop is fully charged and starts from the charging dock. Do not move the charging dock while the vacuum-mop is cleaning.

11 · The above diagram is provided for illustrative purposes only.

Pausing

To resume cleaning, press the button . Press the button  to end the current cleaning task and the vacuum-mop will go back to the charging dock.

Notes:

- To help avoid navigation errors, don't pick up or move the vacuum-mop while it is paused.
- Placing the vacuum-mop onto the charging dock while it is paused will end the current cleaning task.

Sleep Mode

The vacuum-mop will automatically enter sleep mode after 10 minutes of inactivity, then the power and charging indicators will go off. To wake up the vacuum-mop, press any button.

Scheduled Cleaning

You can schedule cleaning time in the Mi Home/Xiaomi Home app. The vacuum-mop will automatically start cleaning at the designated time and then return to the charging dock to recharge when the cleaning is done.

How to Use

Spot Clean mode

When the vacuum-mop is in standby mode or paused, press and hold the button  for 3 seconds to start Spot Clean mode. In this mode, it will clean a square-shaped area of 1.5 x 1.5 meters directly around the vacuum-mop. When the spot cleaning is done, the vacuum-mop will automatically return to its original location and shut off.

Note: Activating Spot Clean mode will end the current cleaning task of the vacuum-mop.

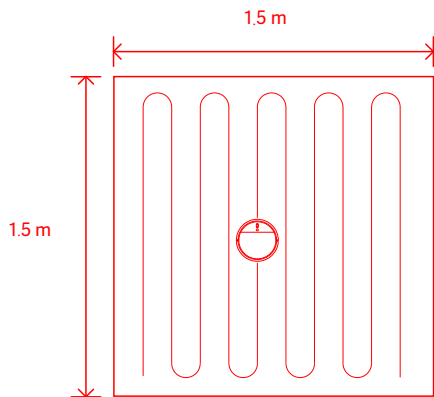

Do Not Disturb Mode

The indicator will go off when the vacuum-mop is in do not disturb (DND) mode. Previously scheduled cleanup tasks will be performed as usual when in DND mode. Unfinished cleaning tasks will not be resumed until the current DND period ends.

Note: After the vacuum-mop is connected with the Mi Home/Xiaomi Home app, the DND mode is enabled by default. You can disable DND or modify DND periods in the app.

More App Features

The Mi Home/Xiaomi Home app offers a variety of special features and different cleaning modes, including Select a Zone to Clean, Zoned Cleanup, App-Configured Restricted Areas/Virtual Walls, Restricted Areas, Clean There, Carpet Boost, and more.

Notes:

- For more information on how to use the features of vacuum-mop in the Mi Home/Xiaomi Home app, please refer to the instructions in the app.
- Please note that certain features may vary due to continuous app updates and enhancements.

How to Use

Using the Mopping Function

1. Install the mop pad

Dampen the mop pad and wring out excess water. Slide the pad all the way into the slot of the water tank until it is securely in place.

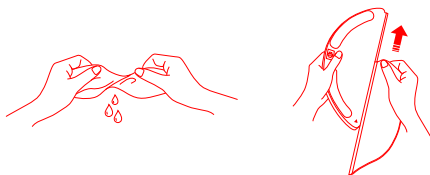

2. Fill the water tank

Open the water tank lid, fill the tank with water, then securely close the lid.

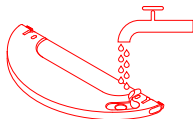

Notes:

- Do not add hot water to the water tank, as this may cause the tank to become deformed.
- To avoid clogging, do not add any cleaning agents or disinfectants to the water tank.

3. Install the mopping assembly

To install the mopping assembly, slide it into the back of the vacuum-mop until it clicks into place.

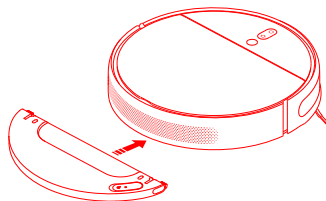

4. Start mopping

Press the button  or use the Mi Home/Xiaomi Home app to start the cleanup. The vacuum-mop will automatically recognize the mopping assembly and begin mopping and dispensing water as needed.

Notes:

- Do not use the mopping function on carpet.
- The mop pad should be cleaned after every 30 minutes of use to ensure adequate water flow and cleaning effectiveness.

How to Use

5. Adding water or cleaning mop pad during cleaning

If you need to add more water to the vacuum-mop or clean the mop pad during a cleaning task, press any button to pause the vacuum-mop, then remove the mopping assembly. After adding water or cleaning the mop pad, reattach the mopping assembly, then press the button  to resume the cleaning task.

Note: To help avoid navigation errors, do not pick up or move the vacuum-mop while it is paused.

6. Adjust water flow rate

The vacuum-mop's water flow rate can be adjusted in the Mi Home/ Xiaomi Home app.

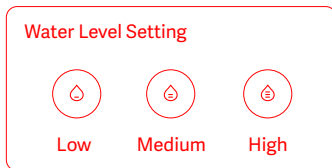

7. Remove the mopping assembly

After the vacuum-mop finishes cleaning and returns to the charging dock, press the side clips of the mopping assembly inward and pull to remove the assembly.

Note: When the vacuum-mop is charging or not in use, remove the mopping assembly, pour out all remaining water in the tank, and clean the mop pad to prevent mildew or lingering odors.

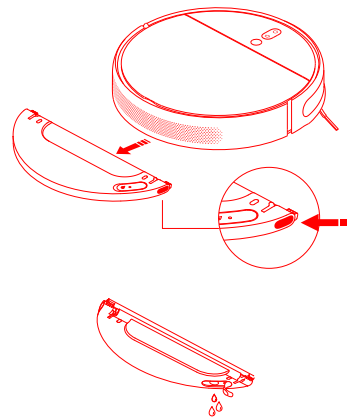

Care & Maintenance

Brush * Weekly cleaning is recommended.

1. Flip the vacuum-mop over and pinch the clips to remove the brush cover.
2. Lift the brush out of the vacuum-mop, then clean the brush bearings.
3. Use the included brush cleaning tool to remove any hairs tangled on the brush.
4. Reinsert the brush, then put the cover back on and press on it until the clips lock into place.

Note: It is recommended to clean the brush weekly and replaced every 6 to 12 months.

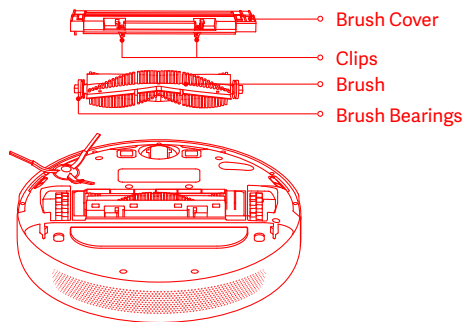

Using the Brush Cleaning Tool

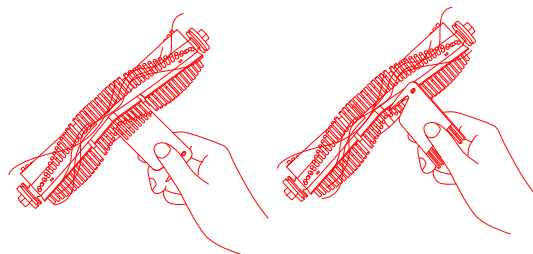

Note: If too much hair is tangled in the brush, or if the hair is tightly tangled, do not forcibly pull on it, as this could damage the brush.

Omnidirectional Wheel * Clean it as needed.

1. Flip the vacuum-mop over and pull out the omnidirectional wheel.
2. Remove hair, dirt, and other debris from the wheel and axle.
3. Reinsert the wheel and press it firmly back into place.

Notes:

- A small screwdriver or other pry tool can be used to gently pop out and remove the wheel.
- The wheel can be cleaned with water and reinstalled after drying.

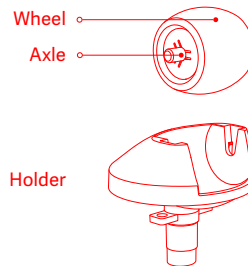

Care & Maintenance

Side Brush * Monthly cleaning is recommended.

1. Flip the vacuum-mop over, then gently pull out the side brush as shown in the diagram below to clean it.
2. Reinstall the side brush.

Note: It is recommended to clean the side brush monthly and replace every 3 to 6 months.

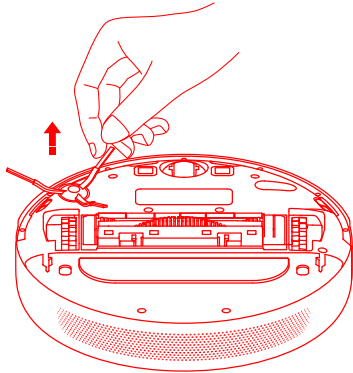

Vacuum-Mop Sensors

Use a soft cloth to clean all sensors in the vacuum-mop, including:

1. The four cliff sensors on the bottom.
2. The charging contacts on the bottom.
3. Optical sensor on the bottom of the vacuum-mop.
4. Infrared deceleration sensor and obstacle sensor on the front of the vacuum-mop.

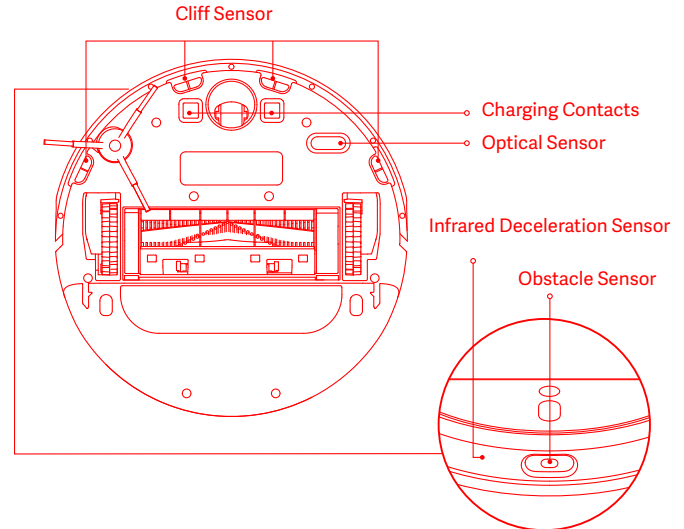

Care & Maintenance

Dust Compartment and Filter

Note: Weekly cleaning is recommended.

1. Open the vacuum-mop cover, then pinch the dust compartment clip to remove the dust compartment.

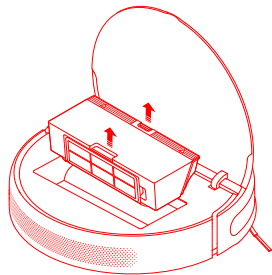

2. Open the dust compartment cover as indicated by the diagram.

Note: To prevent the filter from becoming clogged, lightly tap the dust compartment when emptying its contents.

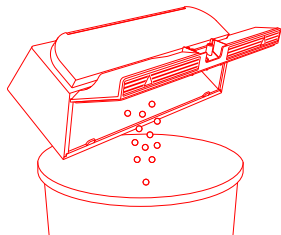

Cleaning the Washable Filter

Note: Biweekly cleaning is recommended.

1. Open the dust compartment cover at the positions marked with arrows.

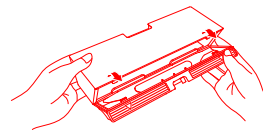

2. Add clean water to the dust compartment, and close the dust compartment cover, then shake the compartment back and forth, finally pour out the water.

Note: Only clean water should be used to clean the filter. Do not use detergent.

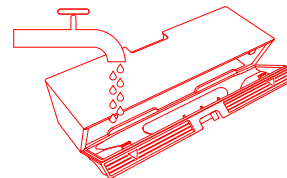

Care & Maintenance

3. Remove the filter, as illustrated, then rinse it out and lightly tap on the edge of the filter to remove dust and debris.

Note: Do not attempt to clean the filter with a brush or finger.

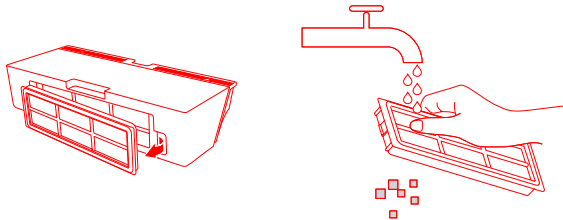

4. Place the dust compartment and filter aside to dry before reinstallation.

Note: Filter must be fully dry before use (allow at least 24 hours).

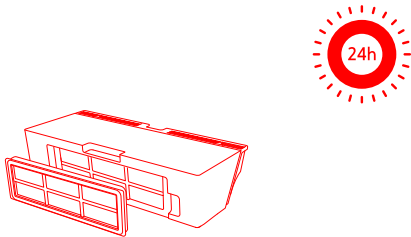

Mop Pad * After-each-use cleaning is recommended.

1. Pull the mop pad off of the mopping assembly to remove it.

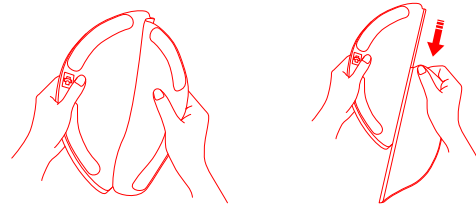

2. Clean and dry the mop pad.

Remove the pad from the mopping assembly before cleaning it, and make sure dirty water does not flow back into the water outlet to avoid clogging. Do not press too hard on the mop pad, as this can hinder its performance. The mop pad should be cleaned before each use.

Note: It is recommended to change the mop pad every 3 to 6 months.

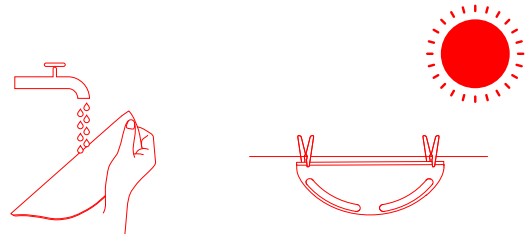

Care & Maintenance

Battery

The vacuum-mop contains a high-performance lithium-ion battery pack. Please ensure that it remains well-charged during daily use to maintain optimal battery performance.

Note: If the vacuum-mop is not used for an extended period, turn it off and put it away. To prevent damage from over-discharging, the vacuum-mop should be recharged at least once every three months.



Charging Dock

Clean the contacts of the charging dock with a soft cloth.

Updating the Firmware

You can update the firmware via the app. Before updating, make sure the vacuum-mop is on the charging dock and has at least 15% battery left.

Restart the Vacuum-mop

If the vacuum-mop stops responding or cannot be turned off, press and hold down the button  for 6 seconds to forcefully turn it off. Then press and hold the button  for 3 seconds to turn the vacuum-mop on.

Restoring Factory Settings

If the vacuum-mop does not function properly after being restarted, use a pin to press the reset button until you hear a voice say "Restoring factory settings". This will reset the vacuum-mop to its original factory settings.

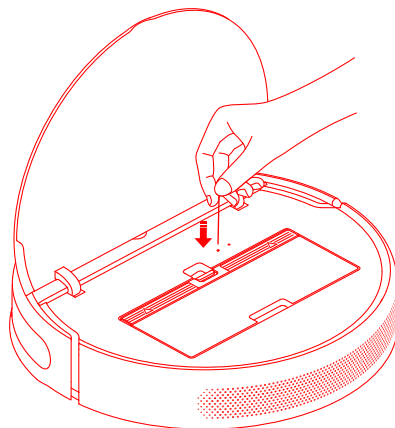

Troubleshooting

If the vacuum-mop encounters an error during operation, the power indicator will blink orange and you will hear a voice alert. To check for a solution, please refer to the table below.

Fault	Solution
Please clean and gently tap the bumper.	If the collision buffer is stuck, gently tap it to remove foreign objects. If it does not work, move the vacuum-mop to a new area and reactivate it.
Please place the vacuum-mop on the level ground and reactivate it.	A wheel is off the ground. Place the vacuum-mop on the level ground and reactivate it.
Please clean the cliff sensor, place the vacuum-mop on level ground, and reactivate it.	Part of the vacuum-mop is off the ground. Place the vacuum-mop on level ground and reactivate it. This error may also occur if the cliff sensor is dirty. To rule out this possibility, clean the cliff sensor.
Please remove the brush and clean the bristles and bearings.	A foreign object might be caught in the brush. Remove the brush and clean its bristles and bearings.
Please remove and clean the side brush.	A foreign object might be caught in the side brush. Remove the side brush and clean it.
Please check whether any objects are wrapped around the main wheels, then move the vacuum-mop to a new location and reactivate it.	A foreign object might be caught in one of the main wheels. Clean the wheels, then reactivate the vacuum-mop.
Please clear any obstacles around the vacuum-mop.	The vacuum-mop may be caught or stuck. Clear away any obstructions around it.
Please reinstall the dust compartment and filter.	Make sure the dust compartment and filter are installed correctly. If the error persists, try replacing the filter.
Strong magnetic field detected. Reactivate the vacuum-mop away from any virtual walls.	The vacuum-mop is too close to a virtual wall. Move the vacuum-mop to a new location, then reactivate it.

Troubleshooting

Charging error. Try cleaning the charging contacts.	Wipe the charging contacts on both the dock and the vacuum-mop with a dry cloth.
Check whether the filter is dry or needs to be cleaned.	The filter may not be dry; if so, make sure it is thoroughly dry for at least 24 hours. The filter may be blocked; if so, try cleaning it. If the issue persists, try replacing the filter.
Please clean the visual navigation sensor.	Wipe the visual navigation sensor, then reactivate the vacuum-mop.
Try resetting the vacuum-mop.	The vacuum-mop cannot continue working due to an internal error. Please try resetting the vacuum-mop.
Try cleaning the obstacle sensor.	Please wipe the obstacle sensor clean and restart.

If the problem still persists, please contact after-sales service for assistance.

FAQ

Problem Type	Solution
What should I do when the vacuum-mop does not turn on?	The vacuum-mop's battery may be low when the ambient temperature is below 0°C or above 40°C, please only use the vacuum-mop in environments with a temperature in the range of 0–40°C. Please charge it before use.
What should I do when the vacuum-mop does not charge?	Check whether the power cord is properly plugged into both the charging dock and the power outlet, and make sure the charging contacts are clean. If not, please wipe the charging contacts on both the dock and the vacuum-mop clean with a dry cloth.
Why doesn't the vacuum-mop return to the dock to charge?	Check whether there are too many obstacles around the charging dock, place the dock in a location without any obstacles around it. Make sure there are no obstacles within 0.5 meters on both sides, nor within 1.5 meters in front of the charging dock. Please clean the dock's signaling area.
What should I do when the vacuum-mop does not work as expected?	Turn off the vacuum mop, and turn it on again.
Vacuum-mop makes a strange noise.	A foreign object might be caught in the brush, side brush, or one of the main wheels. Stop the vacuum-mop and remove any debris.
Why doesn't the vacuum-mop clean as efficiently as before, or leave dust behind?	Please check whether the dust compartment is full, if so empty it. Furthermore, please check the filter and clean it if necessary, and also check whether there is anything wrapped around any of the brushes.
Vacuum-mop cannot connect to Wi-Fi.	Something is wrong with the Wi-Fi connection. Reset the Wi-Fi, then try reconnecting. Location permissions are not enabled. Please ensure your device has location permissions enabled for the Mi Home/Xiaomi Home app. The Wi-Fi signal is weak. Make sure the vacuum-mop is in an area with good Wi-Fi coverage. The vacuum-mop does not support a 5 GHz Wi-Fi connection. Make sure the vacuum-mop is connected to a 2.4 GHz Wi-Fi connection. The Wi-Fi network user name or password is incorrect. Make sure the user name and password used to connect to your Wi-Fi network are correct.

FAQ

Problem Type	Solution
Why doesn't the vacuum-mop carry out the scheduled cleanup?	Check whether the battery level is sufficient. The vacuum-mop needs to have a battery level of 15% or more to start a scheduled cleanup.
Does the vacuum-mop consume electricity when it is left at the dock after being fully charged?	When the vacuum-mop is left at the dock, it will consume a small amount of electricity to allow the battery to maintain optimal performance in sleep mode.
Do I need to charge the vacuum-mop for 16 hours the first three times?	The lithium battery does not suffer from memory effects and can be charged when it suits you. It is not necessary to wait for 16 hours to fully charge the battery.
What should I do when no water or very little water comes out when mopping the floor?	Please check whether the water tank is filled and the mop is properly installed. Please clean the mop on a regular basis.
Too much water comes out of the mopping assembly.	Make sure the water tank lid is securely closed.
Why doesn't the vacuum-mop resume cleaning after charging?	The vacuum-mop does not resume cleaning in do not disturb (DND) mode, or after manually being returned to the dock to charge.
Vacuum-mop doesn't return to charging dock after being moved.	Moving the vacuum-mop may cause it to re-position itself or re-map its surroundings. If the vacuum-mop is too far from the charging dock, it might not be able to automatically return on its own, in which case you need to manually place the vacuum-mop onto the charging dock.

Specifications

Vacuum-Mop

Model	STYTJ02ZHM
Dimensions	353 × 350 × 81.5 mm
Battery	14.4 V --- /4800 mAh (Rated Capacity)
Net Weight	3.7 kg
Wireless Connectivity	Wi-Fi IEEE 802.11b/g/n 2.4 GHz
Rated Voltage	14.4 V ---
Rated Power	40 W
Operation Frequency	2400 - 2483.5 MHz
Maximum Output Power	<20 dBm

Charging Dock

Model	CDZ1902
Dimensions	130 × 126 × 93 mm
Rated Input	100-240 V ~ 50/60 Hz 0.5 A
Rated Output	19.8 V --- 1 A

Under normal use of condition, this equipment should be kept a separation distance of at least 20 cm between the antenna and the body of the user.

WEEE Information



All products bearing this symbol are waste electrical and electronic equipment (WEEE as in directive 2012/19/EU) which should not be mixed with unsorted household waste. Instead, you should protect human health and the environment by handing over your waste equipment to a designated collection point for the recycling of waste electrical and electronic equipment, appointed by the government or local authorities. Correct disposal and recycling will help prevent potential negative consequences to the environment and human health. Please contact the installer or local authorities for more information about the location as well as terms and conditions of such collection points.

For further information, please go to www.mi.com
Manufactured for: Xiaomi Communications Co., Ltd.
Manufactured by: Dreame (Tianjin) Information Technology Co., Ltd.
(a Mi Ecosystem company)

Address: Room 2112-1-1, South District, Finance and Trade Center, 6975 Yazhou Road, Dongjiang Bonded Port Area, Tianjin Pilot Free Trade Zone, 300463 Tianjin, China

Importer:
Beryko s.r.o.
Na Roudné 1162/76, 301 00 Plzeň
www.beryko.cz



Made in China